



## 8-1/2 x 11 Pressure Sensitive Laser Sheets



**1 Label - 8.5 x 11**

\*Compatible with Avery® #5165

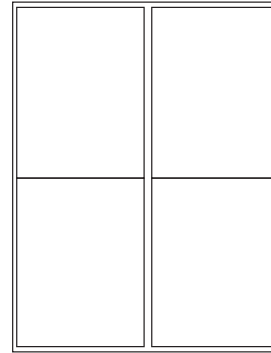

**Label Size - 4 x 5**

\*Compatible with Avery® #6828

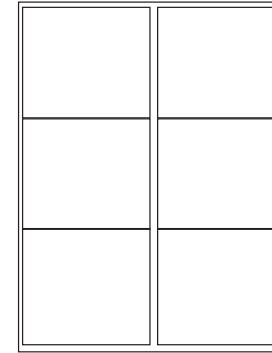

**Label Size - 4 x 3-1/3**

\*Compatible with Avery® #5164

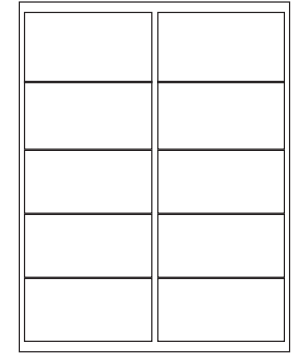

**Label Size - 4 x 2**

\*Compatible with Avery® #5163

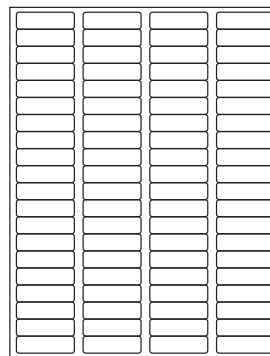

**Label Size - 1-3/4 x 1/2**

Return address labels

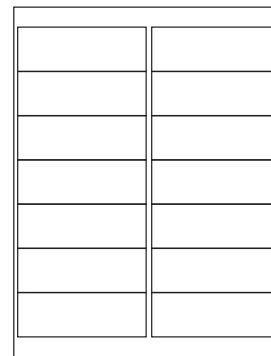

**Label Size - 4 x 1-1/3**

\*Compatible with Avery® #5162

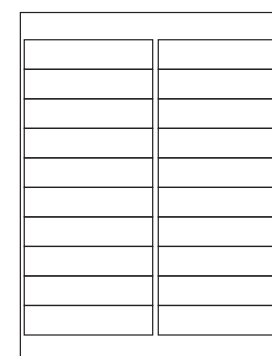

**Label Size - 4 x 1**

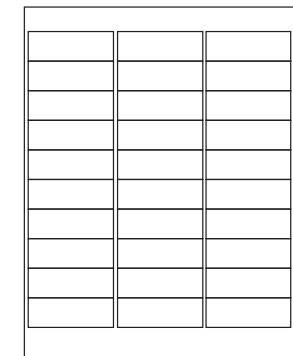

**Label Size - 2-5/8 x 1**

\*Compatible with Avery® #5160

**Ink Jet And Laser Compatible**

**50# Matte Text**

**50# Stay Flat Liner**

**1000 Per Carton**

**Please Call For Test  
Samples - 877-591-9768**



**Label Size - 2-27/32 x 1**

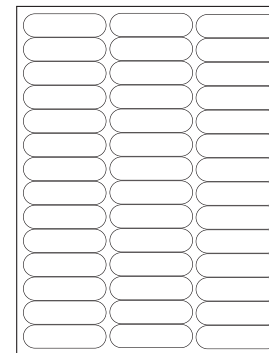

**Label Size - 2-5/8 x 3/4**

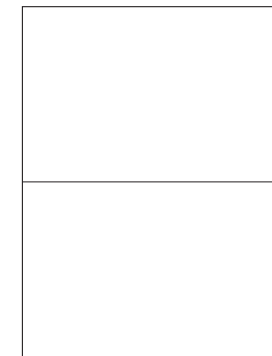

**Label Size - 8-1/2 x 5-1/2**

\*Registered trademark of the Avery Corporation

# Integrated Sheets

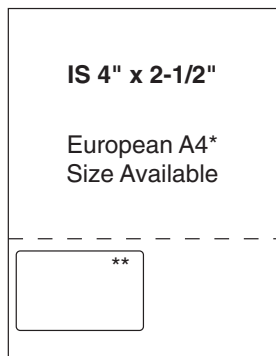

## 1up - 4 x 2-1/2 Label

- Label is 7/8 from bottom and 1/4 from left with perf at 3-3/4
- \* 210mm x 297mm
- \*\* 102mm x 64mm



## 2up - 4 x 2-1/2 Label

- Labels are 3/16 from left & right, 7/8 from bottom, 1/8 between labels with perf at 3-3/4
- \* 210mm x 297mm
- \*\* 102mm x 64mm



## 1up - 8 x 3-1/2 Label

- Label is 1/4 from left & right and 7/8 from bottom
- \* 210mm x 297mm
- \*\* 202mm x 89mm

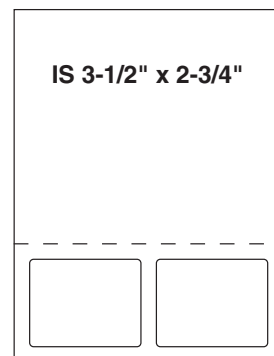

## 2up - 3-1/2 x 2-3/4 Labels

- Labels are 1/2 from left & right, 3/8 from bottom, with 1/2 between labels and perf at 3-5/8

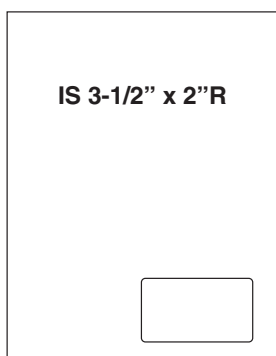

## 1up - 3-1/2 x 2 Label

- Label is 3/4 from right and 5/8 from bottom

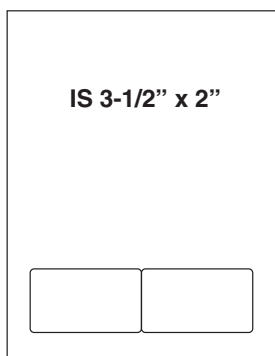

## 2up - 3-1/2 x 2 Labels

- Labels are 3/4 from left & right, 7/8 from bottom with no space between labels

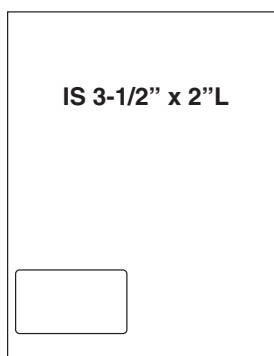

## 1up - 3-1/2 x 2 Label

- Label is 1/4 from left and 7/8 from bottom

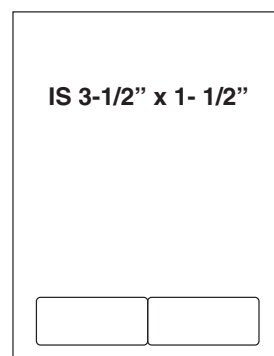

## 2up - 3-1/2 x 1-1/2 Label

- Labels are 1/2 from bottom and 3/4 from left & right with no space between labels

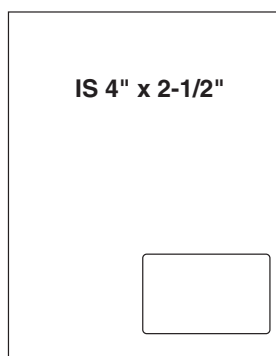

## 1up - 4 x 2-1/2 Label

- Label is 7/8 from bottom and 1/4 from right

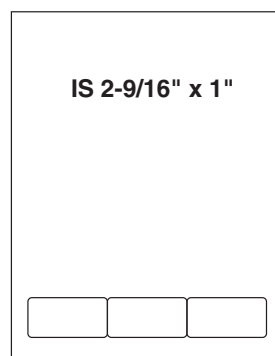

## 2-9/16 x 1 - 3 Across

- Labels are 3/8 from right & left and 3/8 from bottom

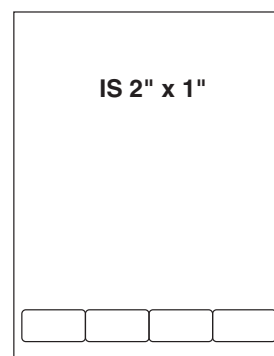

## 2 x 1 - 4 Across

- Labels are 1/4 from right & left and 5/8 from bottom

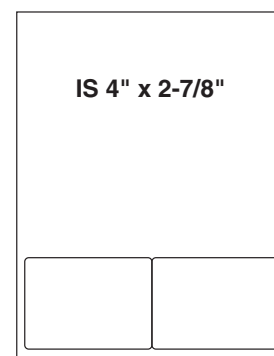

## 2up - 4 x 2-7/8

- Labels are 1/4 from right & left and 3/8 from bottom, with no space between label

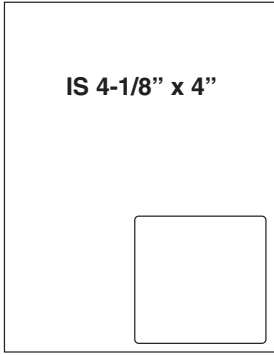

**1 up - 4-1/8 x 4 Label**  
 • Label is 1/4 from bottom and 1/4 from right

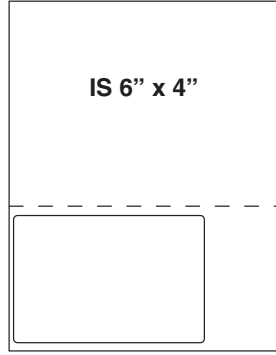

**1 up - 6 x 4 Label**  
 • Label is 1/4 from bottom and 1/8 from left and perf at 4-5/8

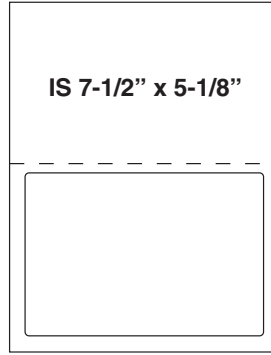

**1 up - 7-1/2 x 5-1/8 Label**  
 • Label is 1/2 from left & right and 1/2 from bottom

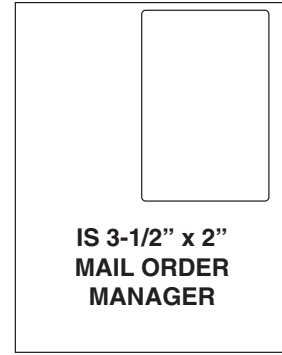

**1 up - 4 x 6 Label**  
 • Label is 1/2 from right and 1/4 from top

- Form size 8.5 x 11
- 24# Laser bond
- 1500 sheets per box
- Also available in 14"

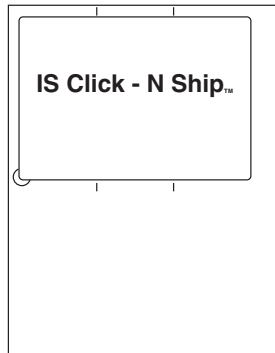

Work With US Post  
 Office Web Site  
 Click-N-Ship™.com  
 U.S. Post Office

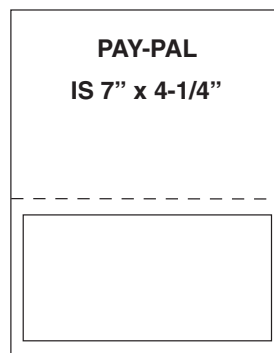

**1 up 7 x 4-1/4 Label**  
 • Label is centered left to right and 1" from bottom perf at 6

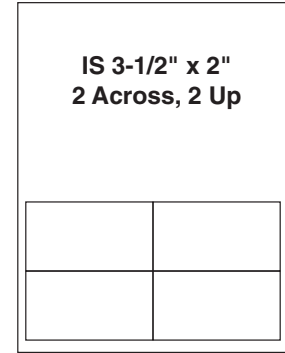

**3-1/2 x 2 - 2 Across, 2 up**  
 • Labels are 3/8 from bottom & 3/4 from right & left with no space between labels

## Thermal Transfer Labels / Direct Thermal

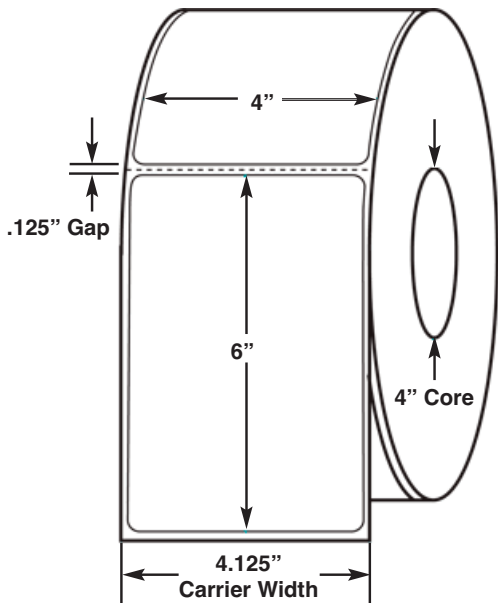

### General use label with Perforation

- 1000 labels per roll
- 4 rolls per carton
- Label size: 4" x 6"
- Carrier size: 4.125" x 6.125"
- White paper stock
- 3 inch Core
- Adhesive permanent
- Labels wound out

# PERF OUT CARD



**Integrated Cards**  
 1up - 3-3/8 x 2-1/8  
 7 point matte stock



**Integrated Cards**  
 2up - 3-3/8 x 2-1/8  
 7 point matte stock

## DUAL WEBS / LABEL FORMS

### PHARMACY FORMS

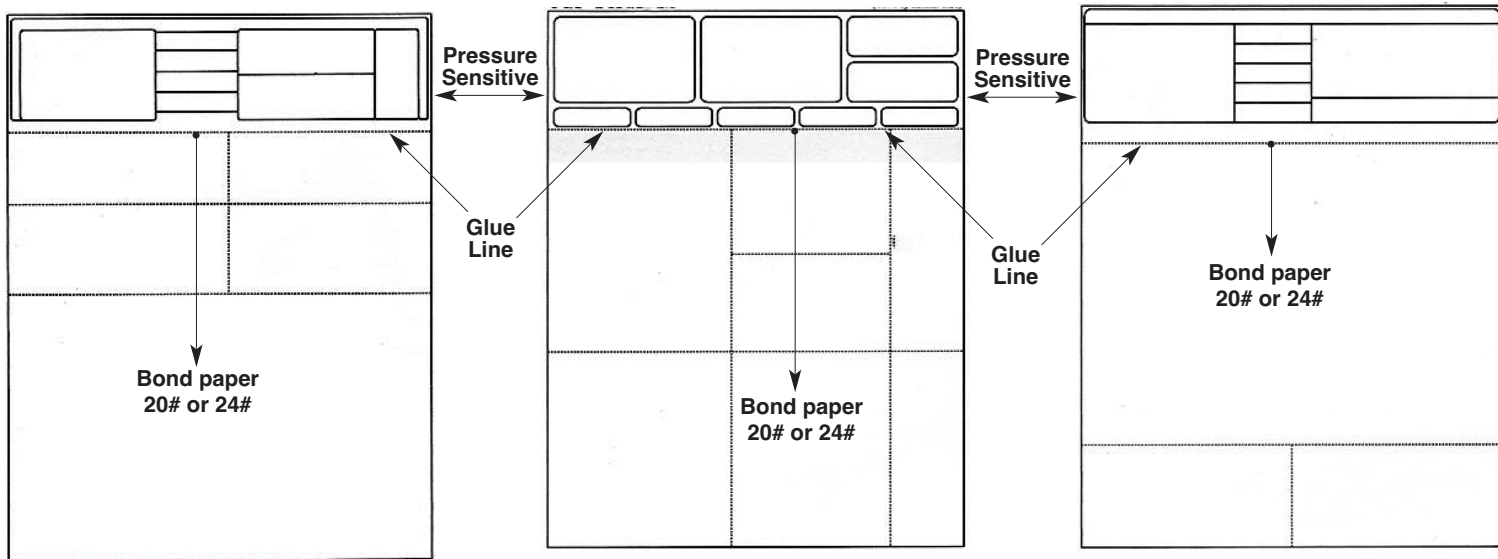

- Computer Paper
- Jumbo Laser Rolls
- Laser Cut Sheets
- Pads
- Wide Format Media
- Pre-Collated Sheets

- Retail Rolls
- Carbonless Forms
- Envelopes
- Copy Paper
- Snap Sets
- Norand Forms

#### Logistic Services:

- End to End Fulfillment
- Warehousing & Distribution
- Third Party Logistics
- Local cartage & Long haul



Products